



RESIDENTIAL HEAT & ENERGY RECOVERY



RESIDENTIAL HRV/ERV

101-284 CFM
WHOLE-HOUSE IAQ SOLUTIONS

TECHNICAL DOCUMENTATION



Discover Heat & Energy Recovery

A tightly built, high-performance home is a great way to conserve energy and lower heating and cooling bills. Without the proper mechanical ventilation system, however, homes suffer from stale air, odors, moisture problems, and poor indoor air quality. Aldes Residential Heat Recovery Ventilators (HRV) and Energy Recovery Ventilators (ERV) combine energy and cost savings with balanced indoor air quality ventilation.

An Aldes HRV/ERV can recover as much as 72% of the heat that would otherwise be exhausted. This 72% translates to real savings on energy bills, all while keeping the home precisely ventilated and climate controlled. These residential models are perfectly suited for use in apartments, condos, and single-family homes up to 4,000 ft².

Compact size and large performance are hallmarks of the Aldes residential models. Each unit is thoughtfully engineered for streamlined installation and durable, worry-free use. Installers will appreciate how quickly it gets up and running. No more fumbling with duct connections, or spending hours on trial-and-error airflow balancing. Once the unit is in place, it works simply, quietly, and efficiently.

Aldes has manufactured ventilation systems and solutions for over 35 years. Every Aldes product is equal parts innovation and experience. Homeowners can trust that their HRV or ERV will last for years and pay for itself in energy savings.

HOW THEY WORK

In the heating season, Heat Recovery Ventilators (HRV) and Energy Recovery Ventilators (ERV) draw in fresh air from outside. This air is distributed throughout the home by a dedicated-duct system or through the forced-air heating / air conditioning system. At the same time, vents located in moisture-and pollutant-producing rooms (e.g., kitchens, bathrooms, laundry rooms) exhaust an equal amount of stale, humid air to the outside. Sometimes air is drawn directly from the return air of a forced-air heating/air conditioning system.

As the two airstreams pass each other in the unit's core, the fresh air is tempered with heat recovered from the exhaust air. An ERV will also transfer moisture to the fresh air if this air is drier than the exhaust air, improving comfort in overly dry homes.

In the cooling season, the reverse occurs. Fresh outdoor air is cooled by the air-conditioned exhaust air. If the outgoing air is drier than the fresh air, the ERV will transfer moisture to the outgoing air. This process reduces the humidity load on the air conditioning system, which would otherwise result in the continuous introduction of humid summer air to the home.

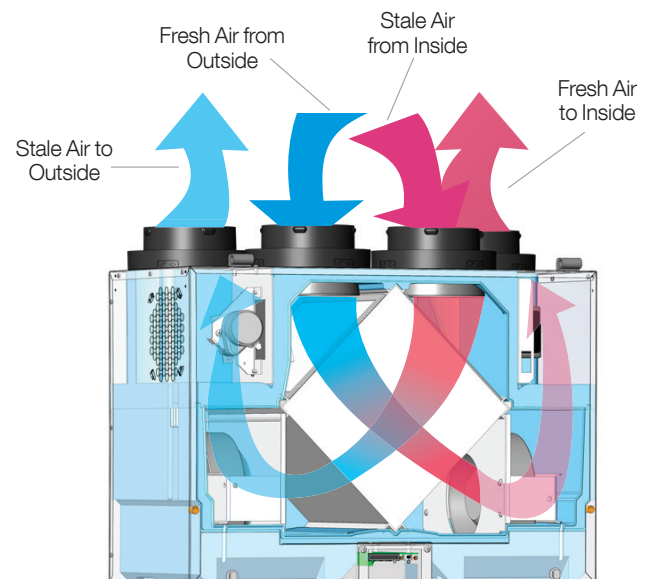



H95-TRG



E110-TF

For the Homeowner

- **Continuous Duty:** Backward-inclined impellers and totally enclosed motors are not susceptible to dust loading and do not need cleaning.
- **Quietly Powerful:** High-efficiency motors are virtually silent and designed to consume very little power.
- **Speed Options:** The unit can operate continuously at low or medium speeds, with on-call high-speed override.
- **Serviceability Ease:** In the event that the unit ever needs servicing, the filters, core, and modularized motor decks can be removed without tools.
- **Superior Insulation:** One-piece molded expanded polystyrene (EPS) is non-porous, so moisture does not get trapped in the unit where it could cause mold to grow.
- **Clean Air:** Multiple filter options are available to enhance the filtration capabilities of the unit, which improves overall indoor air quality.
- **Built to Last:** Painted, heavy-gauge galvanized steel casing is rust-resistant and extremely durable.
- **Effective Recovery:** Units recover up to 72% of sensible heat, shrinking heating and cooling bills.
- **Built-In Defrost:** Automatic fan exhaust or recirculation modes protect the core from freezing in cold climates.
- **Complete Climate Control:** Compatible controllers are available to automate the unit's response to changes in the indoor environment.



For the Installer

- **Quick Calibration with FLEXControl:** Airflow circuits can be electronically calibrated without the need for resistance-inducing balancing dampers. Gauge ports on the door provide fast and reliable airflow readings, and blowers are electronically and independently adjustable.
- **Clever Packaging:** The carton protects the unit in transit, and built-in handles make it easy to remove the unit from the box without damaging any components.
- **Compact Design:** Top-mounted collars minimize unit width for installation in tight spaces. Units can be installed in new construction or existing homes.
- **No-Hassle Duct Connections:** Removable collars can be attached to duct first, then twisted onto the unit.
- **Front Access Panel:** No tools are needed to access the internal components.
- **Lightweight:** Units are light enough for one person to lift and install.
- **Core Options:** Polypropylene (sensible heat recovery) or high-latent-transfer enthalpy (sensible and latent heat recovery) cores are available to accommodate different climates and application needs.
- **Simplified Electronics:** The circuit board is conveniently accessible, and the terminal block can be removed for wiring.
- **Standards Compliant:** All models are ETL safety listed. Select models are also HVI Certified and ENERGY STAR® Qualified (Canada).





H150-TRG & E150-TRG



H190-TRG & E190-TRG



H280-SRG & E280-SRG

Model	Airflow @ 0.2 po H ₂ O	Unit Type	ENERGY STAR® (Canada)	HVI Certified	Core Type	Defrost Mode	Number of Ports	Duct Connections	Recirculation Port Location	Access Panel
H95-TRG	106 CFM	HRV	✓	✓	Polypropylene	Recirculation	5	Top	Side	Front
E110-TF	101 CFM	ERV			High Latent Transfer	Fan Exhaust	4	Top	N/A	Front
H120-TQG	108 CFM	HRV		✓	Polypropylene	Recirculation	4	Top	N/A	Front
H150-TQG	133 CFM	HRV	✓	✓	Polypropylene	Recirculation	4	Top	N/A	Front
H150-TRG	142 CFM	HRV	✓	✓	Polypropylene	Recirculation	5	Top	Side	Front
E150-TRG	125 CFM	ERV	✓	✓	High Latent Transfer	Recirculation	5	Top	Side	Front
H190-TQG	218 CFM	HRV	✓	✓	Polypropylene	Recirculation	4	Top	N/A	Front
H190-TRG	222 CFM	HRV	✓	✓	Polypropylene	Recirculation	5	Top	Side	Front
E190-TRG	191 CFM	ERV	✓	✓	High Latent Transfer	Recirculation	5	Top	Side	Front
H280-SRG	284 CFM	HRV	✓	✓	Polypropylene	Recirculation	5	Side	Top	Front
E280-SRG	269 CFM	ERV	✓	✓	High Latent Transfer	Recirculation	5	Side	Top	Front

KEY FEATURES



QUALITY DEFINED BY DESIGN

- FLEXcontrol - Allows for fast and easy electronic balancing without dampers, while providing quiet and efficient operation.
- EPS Casing - Equipment structure design with EPS casing.

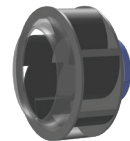
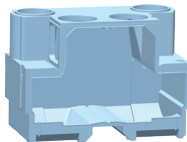

EQUIPMENT STRUCTURE DESIGN WITH EPS CASING (EXPANDED POLYSTYRENE)

Provides exceptional air and water tightness preventing air stream contamination and odour transfer. No thermal bridges, increasing performance.

HIGH EFFICIENCY SEALED BACKWARD INCLINED MOTORS

High efficiency sealed backward inclined motors, providing energy savings. 5 year limited warranty. Non-dust-loading impellers on totally enclosed motors.

REMOVABLE PORTS

Twist-in collars for easy installation. Provided with retention dimples at the top of ports to tie flex duct. Top-mounted ports minimize unit width.

PROGRAMMABLE CONTROL BOARD

Easy access to PCB providing fast and easy set up of FLEXcontrol. Removable terminal block for easy installation.

6

DIMENSIONS & MOUNTING

INSTALLATION CONFIGURATION OPTIONS

Side View

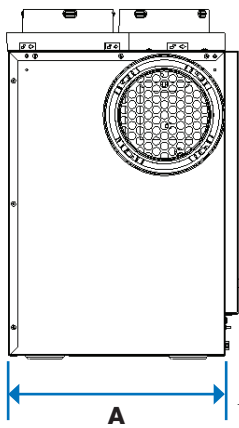

Front View

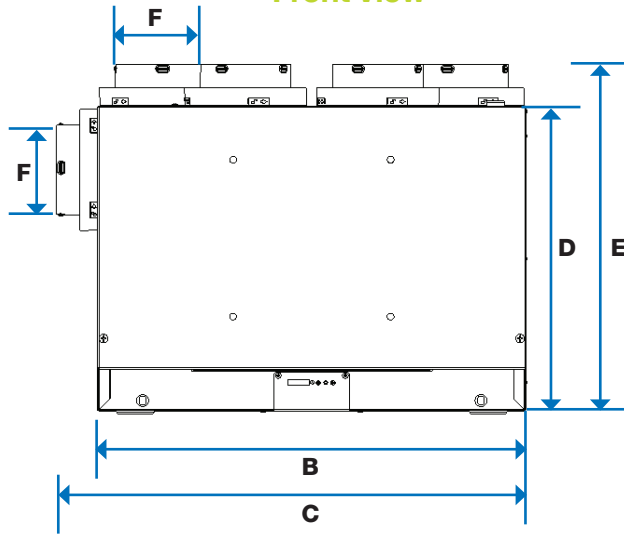

MODEL(S)	A Cabinet Depth	B Cabinet Width	C Width w/ 5th Port	D Cabinet Height	E Height w/Collars	F Duct Collar Diameter	Unit Weight*
H95-TRG	12-3/8" (314 mm)	23-1/8" (587 mm)	25-3/8" (645 mm)	16-3/4" (425 mm)	19" (483 mm)	5" (127 mm)	30 lbs (13 kg)
E110-TF & H120-TQG	12-3/8" (314 mm)	23-1/8" (587 mm)	N/A	16-3/4" (425 mm)	19" (483 mm)	4" (102 mm)	29 lbs (13 kg)
H150-TQG	12-3/8" (314 mm)	23-1/8" (587 mm)	N/A	16-3/4" (425 mm)	19" (483 mm)	5" (127 mm)	32 lbs (15 kg)
H150-TRG & E150-TRG	12-3/8" (314 mm)	23-1/8" (587 mm)	25-3/8" (645 mm)	16-3/4" (425 mm)	19" (483 mm)	5" (127 mm)	32 lbs (15 kg)
H190-TQG	15-11/16" (398 mm)	29-5/16" (745 mm)	N/A	19-7/16" (494 mm)	21-11/16" (551 mm)	6" (152 mm)	50 lbs (23 kg)
H190-TRG & E190-TRG	15-11/16" (398 mm)	29-5/16" (745 mm)	31-9/16" (802 mm)	19-7/16" (494 mm)	21-11/16" (551 mm)	6" (152 mm)	50 lbs (23 kg)
H280-SRG & E280-SRG	17-1/16" (433 mm)	31" (787 mm)	33-1/4" (845 mm)	21-3/4" (552 mm)	24" (610 mm)	6" (152 mm)	62 lbs (28 kg)

* Shipping weight will vary

Two Mounting Options

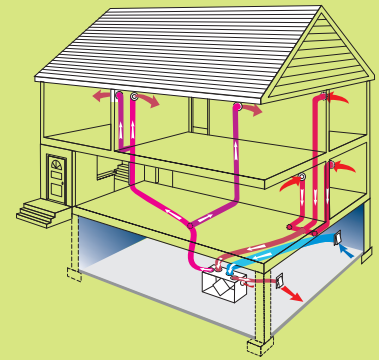

Fully Ducted System

The most desirable configuration. Highly recommended to get the best results in all climate types.

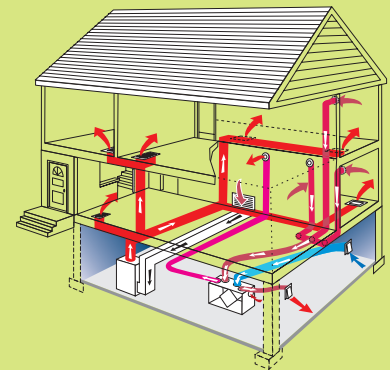

Dedicated Exhaust Points with Distribution of Fresh Supply Air through the Central H/AC System

A hybrid approach that allows the system to be an effective exhaust fan, while taking advantage of the central H/AC duct system to distribute fresh air. Maintaining unit balance is often challenging.

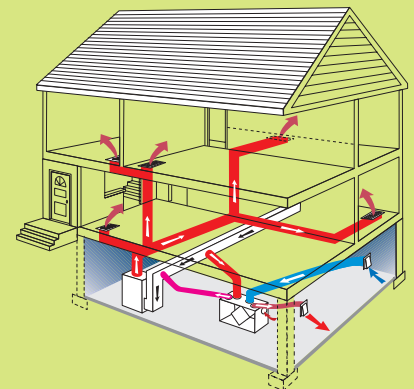

Exhaust from H/AC Return and Distribution of Fresh Air through H/AC System

The least desirable solution because it is difficult to assure balanced airflow and can cause moisture problems in duct during warm, humid seasons. Requires knowledgeable installer.

Choosing between an HRV and an ERV is not always straightforward. It depends on many factors— house square footage, number of occupants, tightness of the building envelope, and climate, among others—but the presence of outdoor humidity is often the deciding factor.

The map at right shows that an ERV is the best choice for the hot and humid conditions of the southern United States. An ERV is more cost effective when paired with an air conditioner. In very cold climates, there is not enough difference in moisture levels between indoor and outdoor air for homes to benefit from the moisture-transfer capabilities an ERV.

Areas that experience cold winters and warm summers are candidates for an HRV or ERV. Specific instances, such as indoor relative humidity problems, can make one more suitable than the other.

The best way to decide is to consider the variables, then consult a local Aldes representative or call 1.800.255.7749.

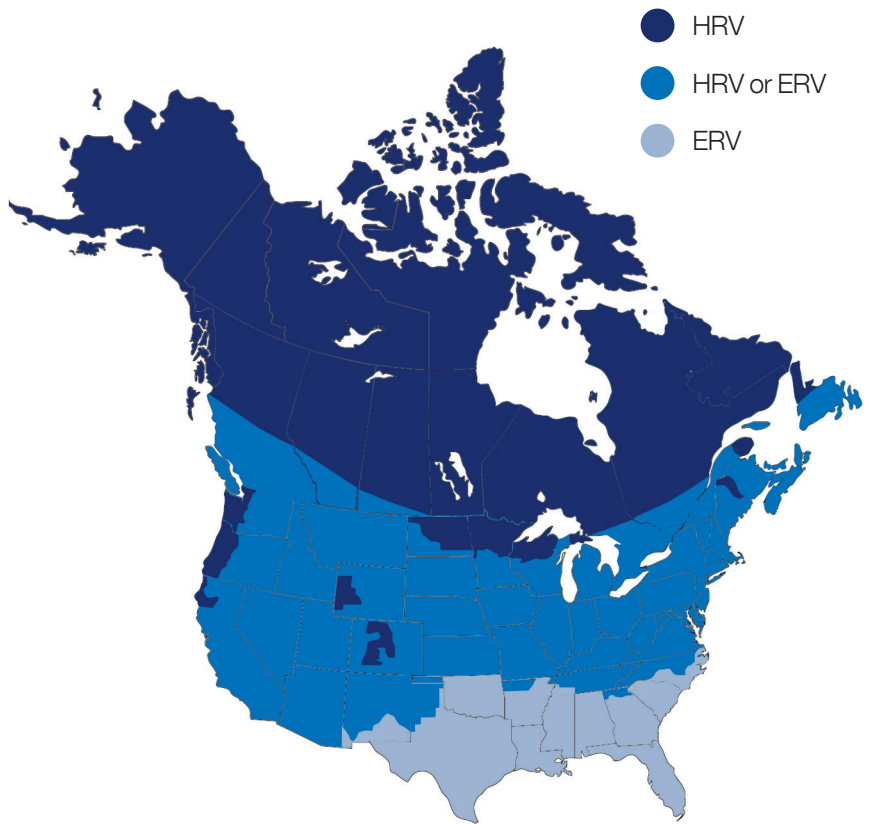

Accessories*



20/40/60 Timer
(P/N 611228)



Speed Control
(P/N 611229)



Mode Control
(P/N 611230)



Multifunction Control
(P/N 611242)

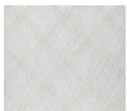

MERV 6 Filter



MERV 8 Filter

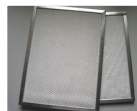

High-Efficiency Filter

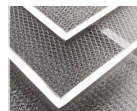

Aluminum Filter



Zone Register Terminal (ZRT-1)



Zone Register Terminal (ZRT-2)



Constant Airflow Regulator (MRv2)

* Compatibility varies by product. Please consult individual specification sheets for complete details. Zone Register Terminals are sold with select models as part of VentZone® Zoned IAQ Kits with Heat/Energy Recovery.

Limited Warranty

HRV Core: Lifetime

ERV Core: 5-years

Controls: 2-years

All Other Covered Components: 5-years

Cleaning & Maintenance

Unit maintenance is minimal and can be done by the homeowner. Special cleaning products are not required. All units include an installation and operations manual with specific care instructions.

Core

Clean annually.

Filters

Vacuum seasonally. Replace annually.

Cabinet Interior

Clean annually.

Motors

No cleaning required.

VENTZONE® SYSTEMS
ARE THE MOST
ENERGY EFFICIENT
VENTILATION SYSTEM
ON THE MARKET TODAY.

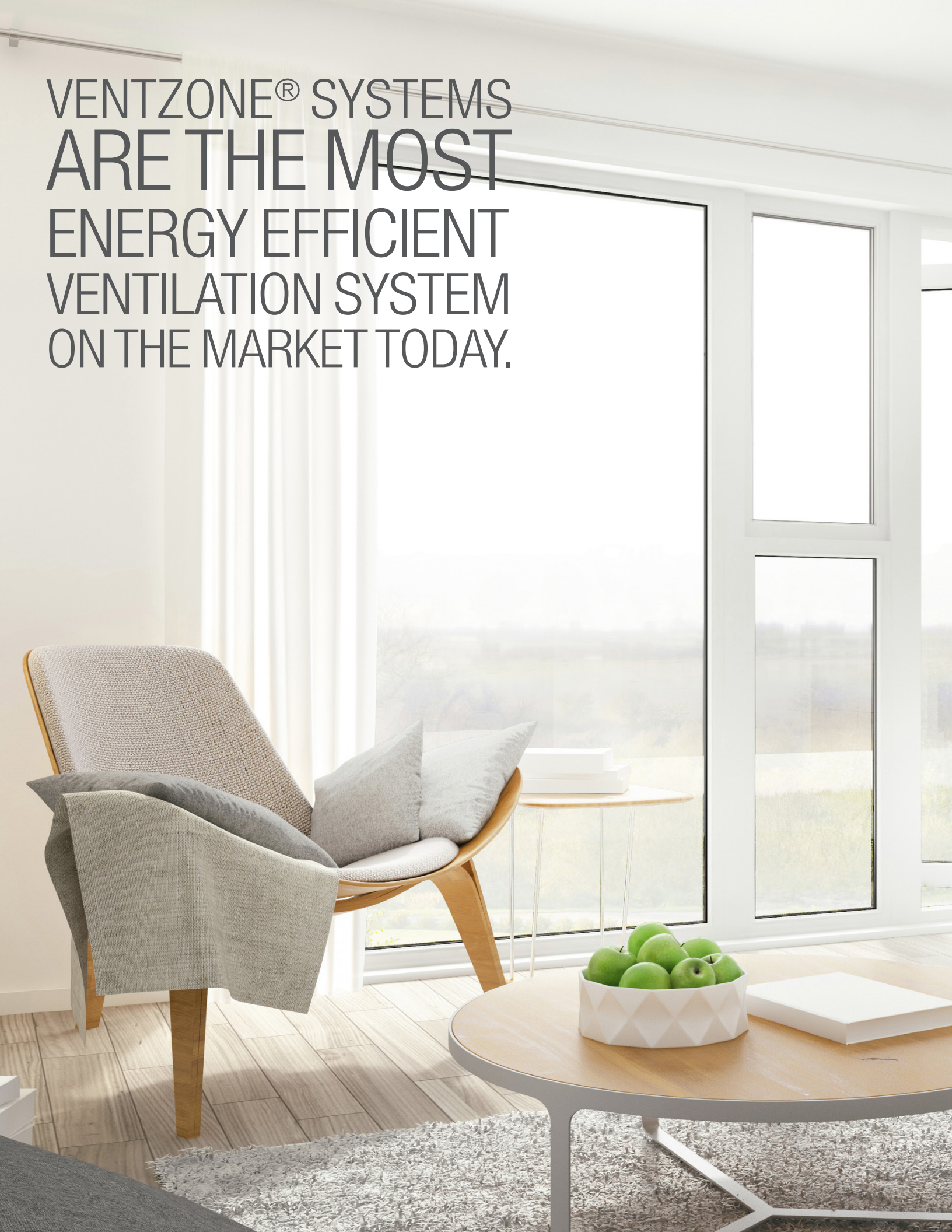

VENTZONE® IAQ WITH HRV OR ERV KEY BENEFITS

Combination of centralized zoned exhaust ventilation, whole house IAQ and heat and energy recovery make this system efficient and innovative.

Homeowners benefit from healthy indoor air quality throughout the home with extra boost ventilation in bathrooms as needed.

The entire ventilation system only requires two penetrations to the outside of the home, as opposed to one for each bathroom, plus two for the ERV with other systems.

Compatible controllers are available to automate the system's response to changes in the indoor environment.

The new and improved air exchanger models each feature an onboard 24V low-voltage power supply to power up to 5 zone register terminals. The entire system is designed for installation by a single trade in most cases. Check local codes.



VentZone® Systems and the patented Zone Register Terminals® (ZRT) have both earned the American Society of Heating, Refrigeration, Air Conditioning Engineers (ASHRAE) Innovation Award for ventilation.



aldes
ZRT®
VentZone® Systems



Two of our most popular products make up the VentZone® System: The Zone Register Terminal® - Residential version (ZRT-R) and an ALDES Heat or Energy Recovery Ventilator (HRV or ERV).

ALDES ZRTs provide the zoned bathroom exhaust, and it's unlike anything else on the market today.

Other systems typically ventilate bathrooms in one of two ways:

1. Individual fans for each bathroom. This is expensive since you must buy, install, and create a penetration in the exterior wall of the home for each bathroom.
2. Inline bathroom fan connected to all bathrooms. These remote fan kits waste energy and can over ventilate a home since all bathroom exhaust is either on or off and does not allow the occupant to operate ventilation in each bathroom independently.

THE ALDES WAY

Centralized zoned bathroom exhaust. ZRTs take the place of individual fans or grilles like those found on remote inline fan kits. ZRTs are multifunctional in that they can provide two types of ventilation.

1. Continuous low-level ventilation every home needs to keep indoor air healthy.
2. Boosted ventilation as needed to remove humidity, odors and other pollutants in the bathroom.





ZRTs control the ventilation so that individual bathrooms are only exhausted as needed. Also known as demand controlled ventilation, controlling the airflow on a zone-by-zone basis saves energy and reduces the load on heating and cooling systems.



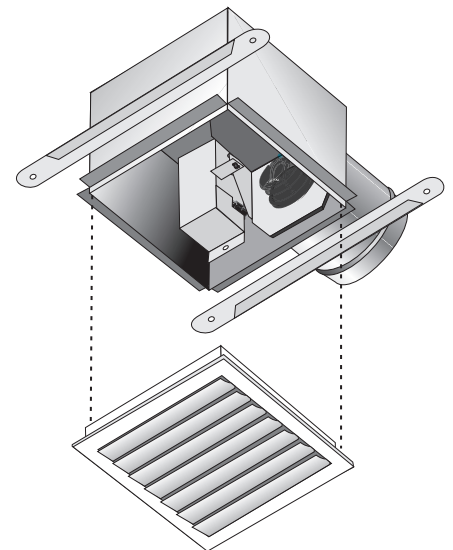

How do ZRTs work with the ventilator to control airflow?



Each ZRT can control a specified amount of continuous whole house IAQ ventilation through a constant airflow regulator when the damper is closed. When called upon by any switch, timer, dehumidistat, or occupancy sensor, the ZRT damper opens and ventilates at a higher rate of CFM to rapidly remove steam, odors or other indoor pollutants. Low-voltage power to operate controls and ZRTs are supplied from the ALDES heat or energy recovery ventilator. These are the only air exchangers in the industry to provide this ease of installation, time and cost savings benefit. The ZRTs exhaust air via an ALDES heat or energy recovery ventilator. During normal operation, the air exchanger is operating at a specified lower level of air flow needed for whole house indoor IAQ. When activated by a zoned ZRT control, the air exchanger automatically ventilates at a higher rate to provide boosted ventilation to that space only. Maintaining the low-level ventilation in bathrooms not requiring boosted ventilation.

This provides energy efficient, balanced ventilation, so when air is being exhausted from the home, fresh air is also being brought in. This avoids negative pressure on the home and improves indoor air quality while maximizing energy recovery.



VentZone® Zoned IAQ Kits with Heat Recovery						
Number of Bathrooms	Airflow @ 0.2 in. w.g.	Ventilator	6" ZRT-2-6-24R (24V) 10/20/30 CFM	4" ZRT-2-4-24R (24V) 10/20/30 CFM	4" ZRT-1-4-24R (24V)	20/40/60 Push Button Timer
						
2	140 CFM	H150-TQG or H150-TRG	--	2	--	2
2	140 CFM	H150-TQG or H150-TRG	--	2	--	2
2.5	140 CFM	H150-TQG or H150-TRG	--	2	1	3
2.5	220 CFM	H190-TQG or H190-TRG	1	1	1	2
3	220 CFM	H190-TQG or H190-TRG	1	2	--	3
3.5	220 CFM	H190-TQG or H190-TRG	1	2	1	4
4.5	220 CFM	H190-TQG or H190-TRG	1	3	1	5
5	220 CFM	H190-TQG or H190-TRG	1	4	--	5

VentZone® Zoned IAQ Kits with Energy Recovery						
Number of Bathrooms	Airflow @ 0.2 in. w.g.	Ventilator	6" ZRT-2-6-24R (24V) 10/20/30 CFM	4" ZRT-2-4-24R (24V) 10/20/30 CFM	4" ZRT-1-4-24R (24V)	20/40/60 Push Button Timer
						
2	125 CFM	E150-TRG	--	2	--	2
2.5	125 CFM	E150-TRG	--	2	1	3
2.5	191 CFM	E190-TRG	1	1	1	2
3	191 CFM	E190-TRG	1	2	--	3
3.5	191 CFM	E190-TRG	1	2	1	4
4.5	191 CFM	E190-TRG	1	3	1	5
5	191 CFM	E190-TRG	1	4	--	5

Accessories for VentZone® Kits			
Part Number	Description	ZRT-1-6-24R	Digital Multifunction Wall Control
			
R39 550-24	ZRT and multi-function wall control	1	1



U.S. Patent #7,766,734 and Canada Patent #2,570,948



For more information, contact your
Aldes sales advisor, visit aldes-na.com,
or find us on



Aldes North America
USA 800.255.7749 CAN 800.262.0916

0622 - Residential HRV/ERV Brochure.
©2022 American ALDES Ventilation Corporation and ALDES Canada. All Rights Reserved.
Reproduction or distribution, in whole or in part, of this document, in any form or by any means, without the express written consent of American ALDES Ventilation Corporation and/or ALDES Canada, is strictly prohibited.
The information contained within this document is subject to change without prior written notice.

